

3 601 JC3 200
Issue |
Stand | 19-01-21 **Fig./Abb. 2**

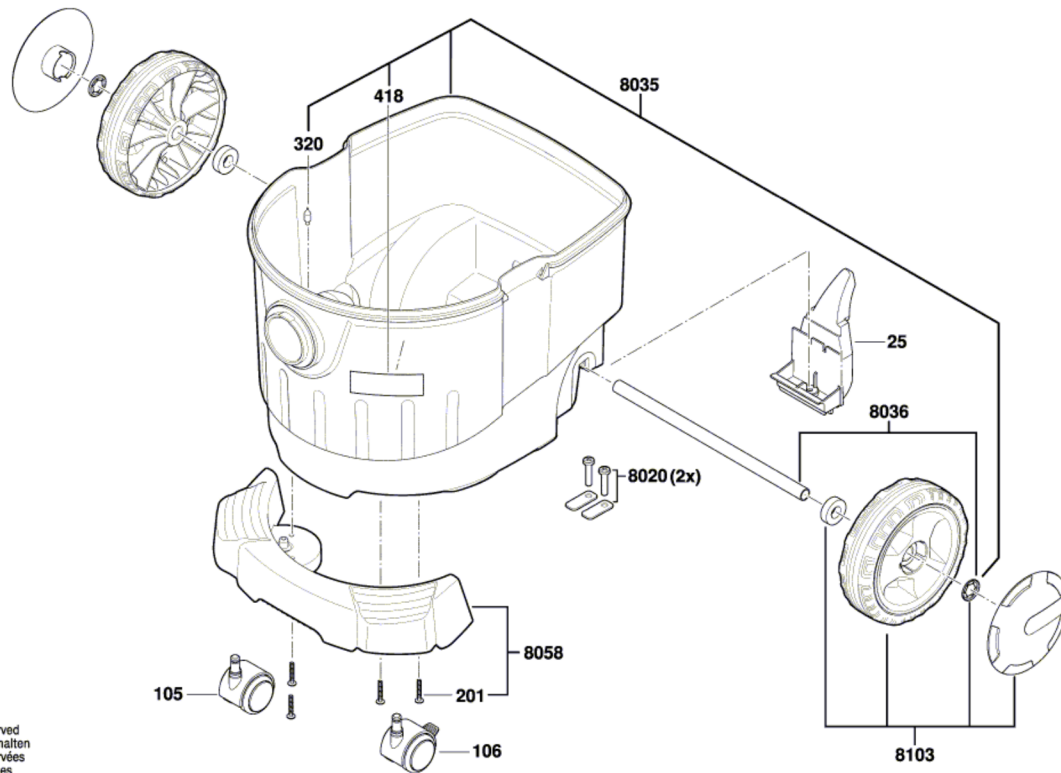

Modifications reserved
Änderungen vorbehalten
Modifications réservées
Salvo modificaciones