

0 611 226 503; 543
 Issue
 Stand 06-09-25

Fig./Abb. 2

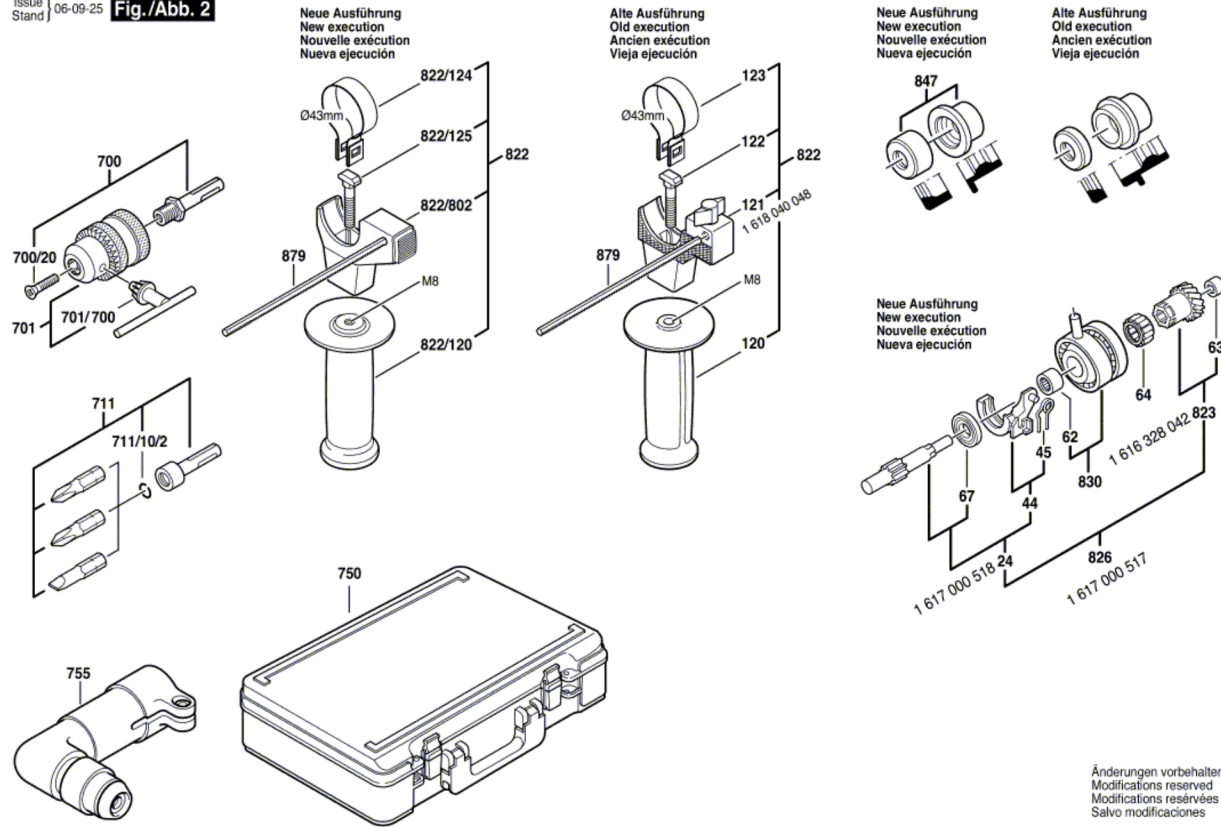

Änderungen vorbehalten
 Modifications reserved
 Modifications réservées
 Salvo modificaciones