

3 601 H22 000

Stand } 08-06
Issue } 07-02-12

Fig./Abb. 2

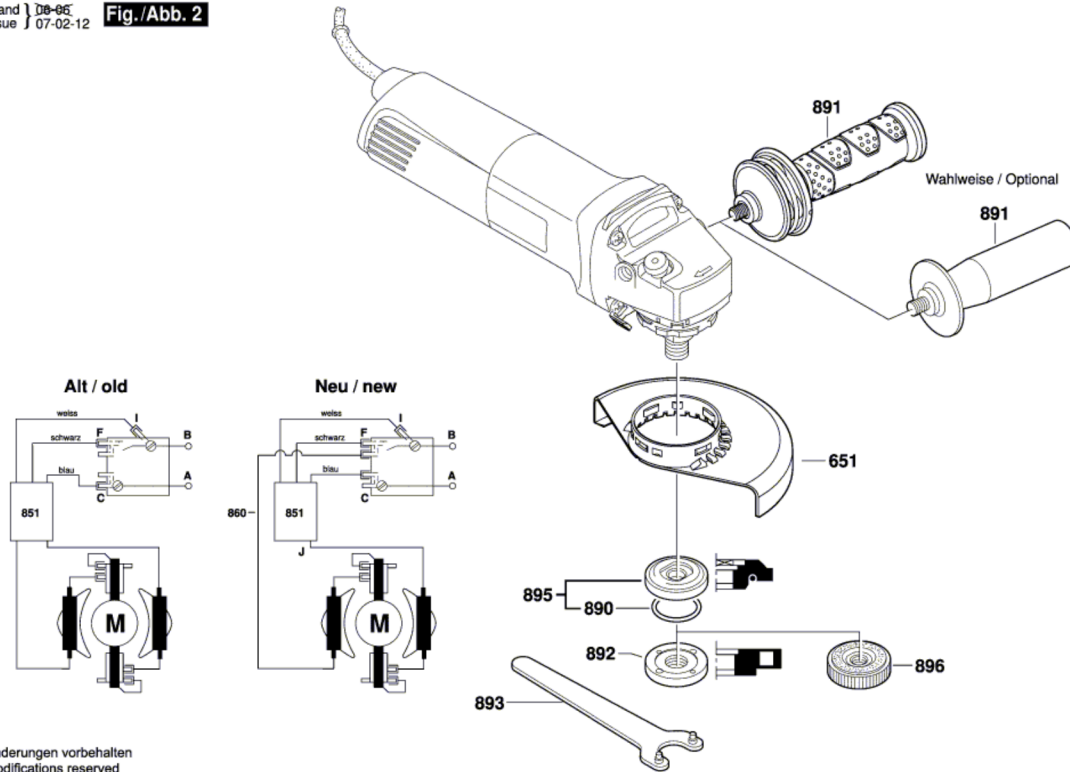

Änderungen vorbehalten
Modifications reserved
Modifications reserves
Salvo modificaciones