

3 603 D13 000  
Stand } 12-03  
Issue } 15-03-31

Fig./Abb. 1

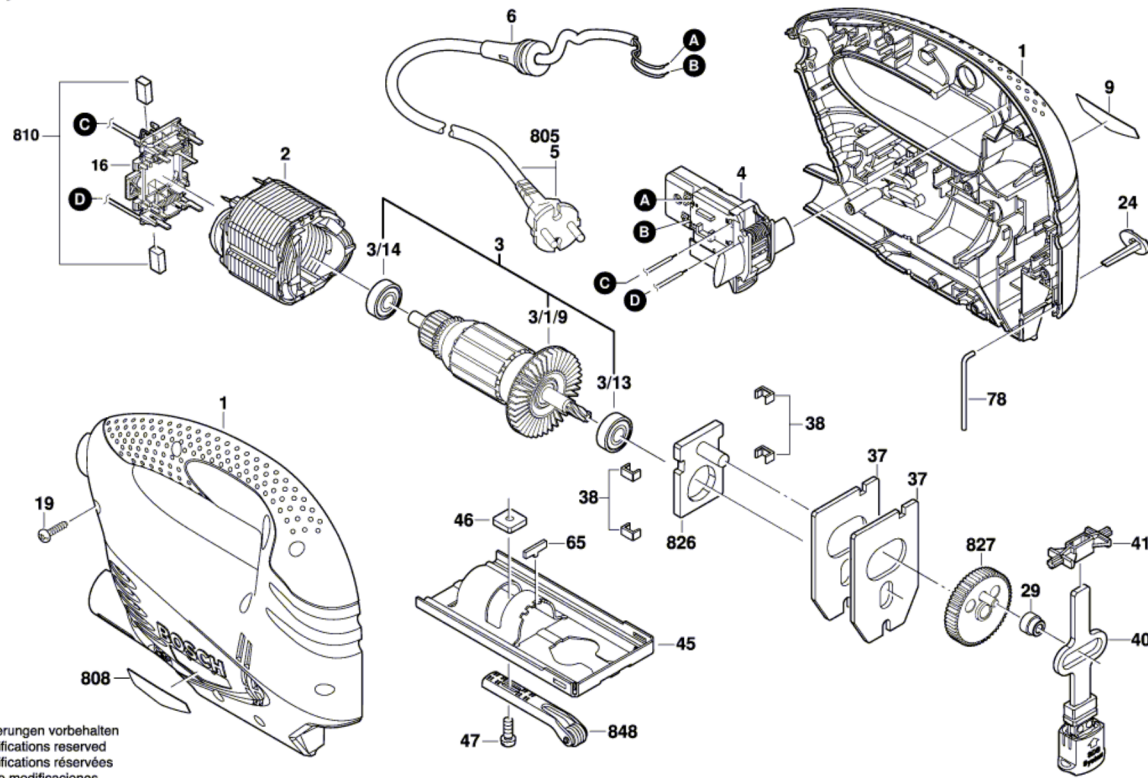

Änderungen vorbehalten  
Modifications reserved  
Modifications réservées  
Salvo modificaciones