

0 603 362 703
Stand 03-02-06
Issue

Fig./Abb. 1

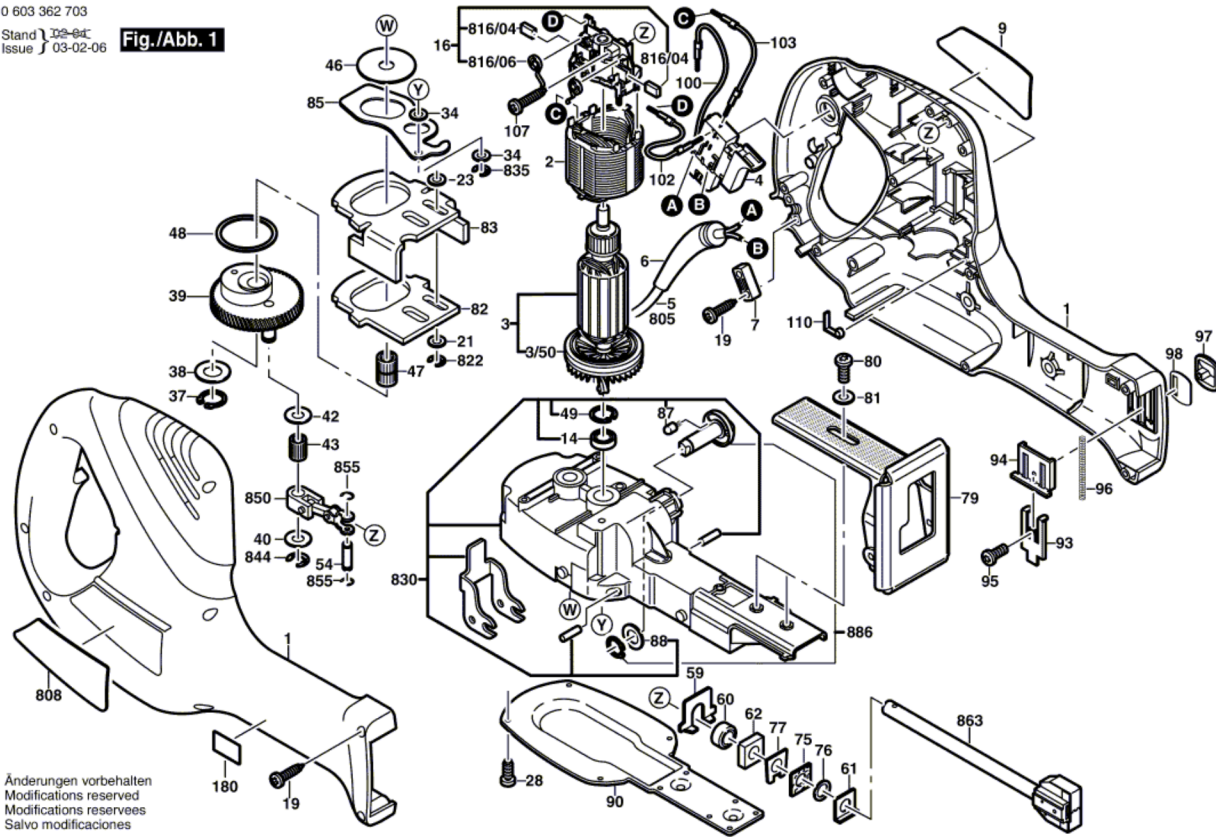

Änderungen vorbehalten
Modifications reserved
Modifications reserves
Salvo modificaciones