

0 601 049 603  
 Issue  
 Stand 14-03-05

**Fig./Abb. 1**

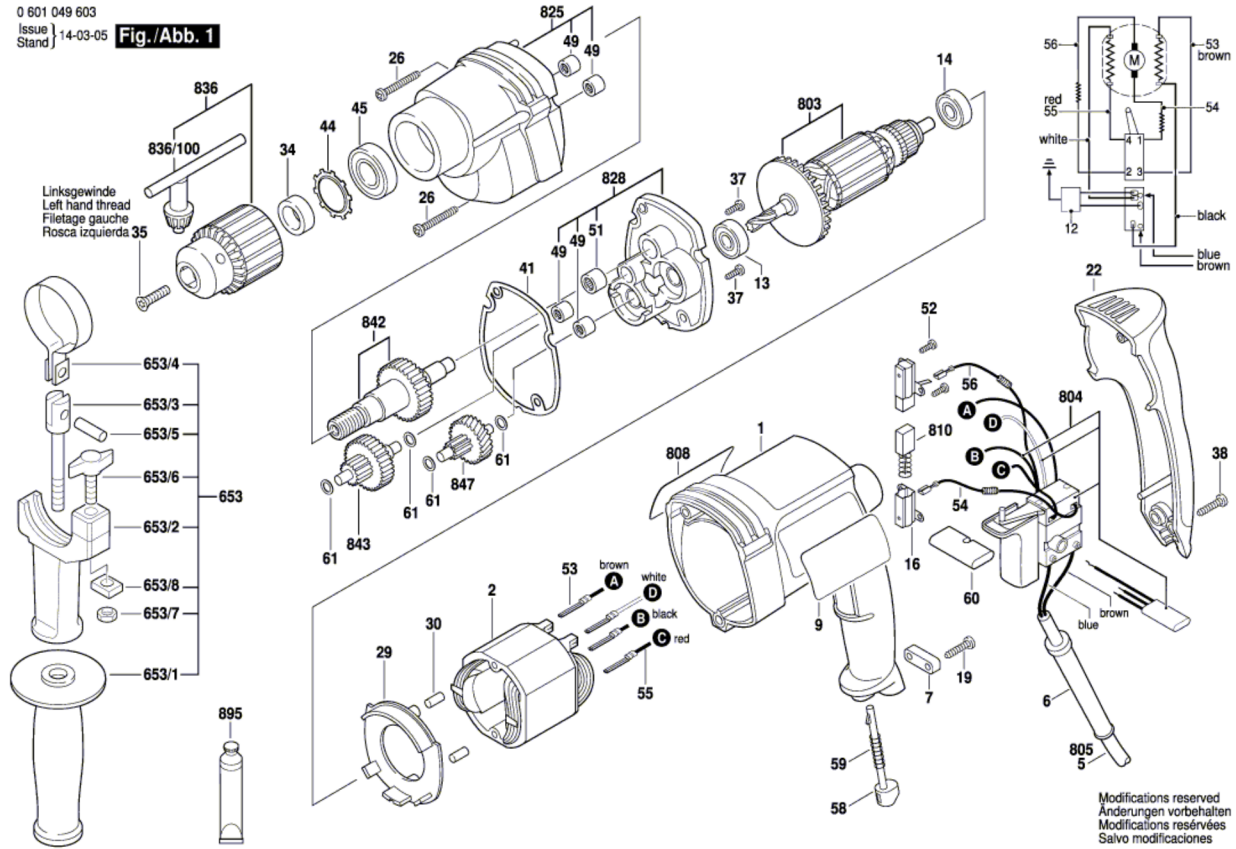

Modifications reserved  
 Änderungen vorbehalten  
 Modifications réservées  
 Salvo modificaciones