

0 603 338 603

Stand 1 08-08

Issue J 07-02-13

Fig./Abb. 1

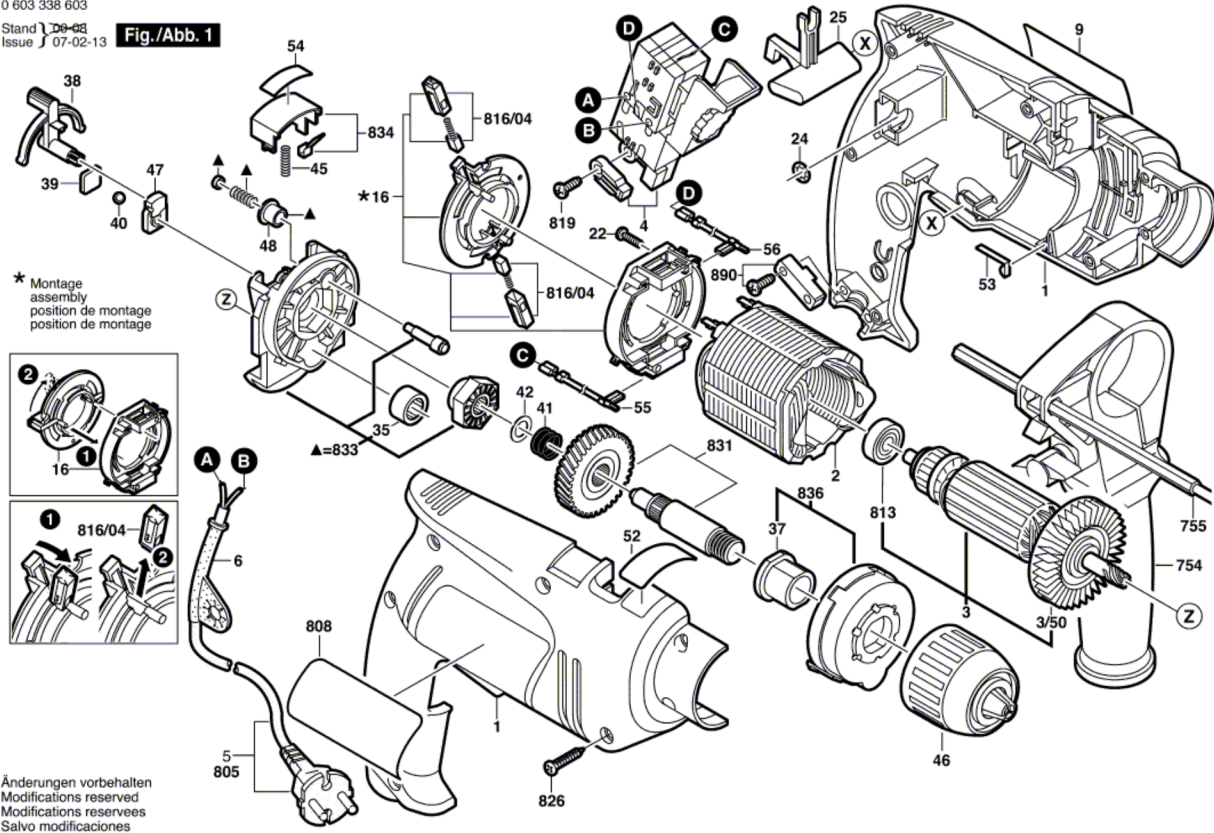

* Montage
assembly
position de montage
position de montage

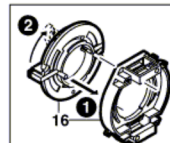

Änderungen vorbehalten
Modifications reserved
Modifications reserves
Salvo modificaciones