

3 601 B37 080
 Issue
 Stand 16-09-13

Fig./Abb. 1

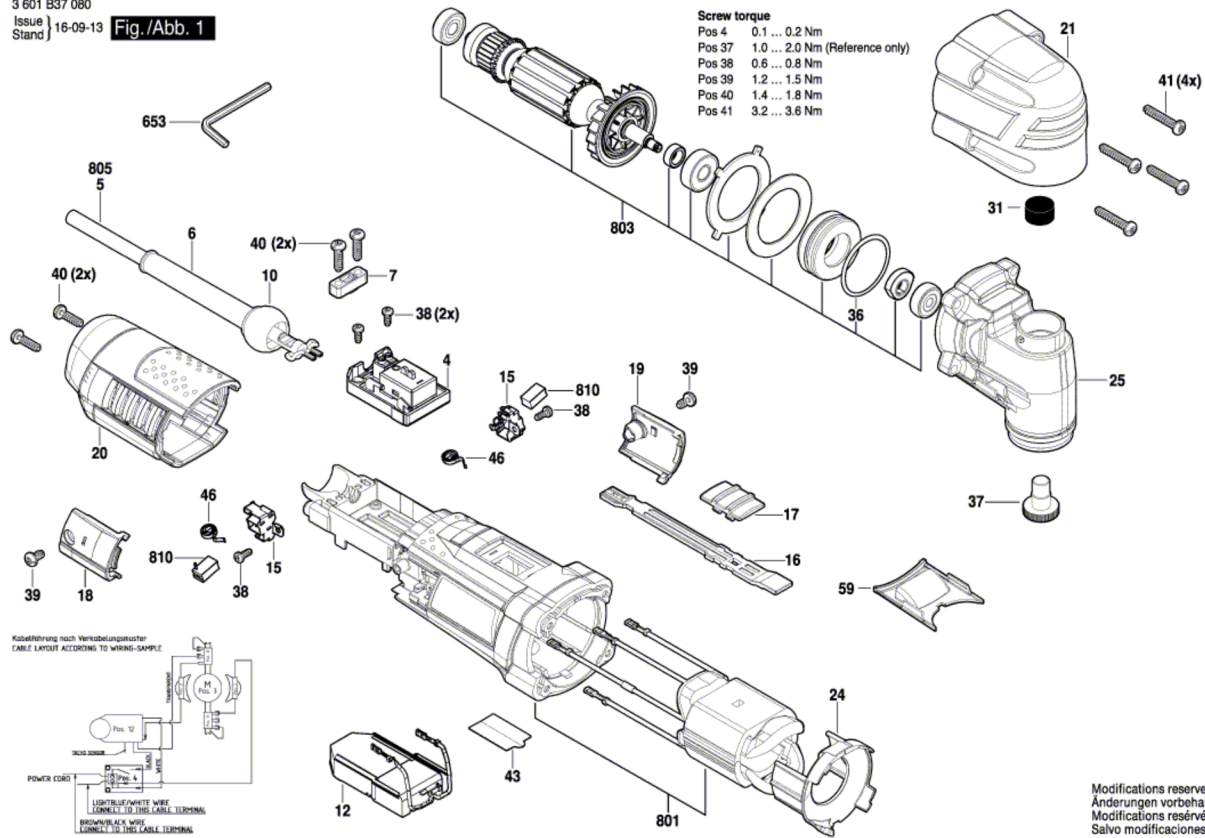

Modifications reserved
 Änderungen vorbehalten
 Modifications réservées
 Salvo modificaciones